

# **iCleaner-200 User Manual**

Hangzhou Gaoyue Technology Co., Ltd.  
<http://www.ichroboter.com>

February 2014

# Catalogue

<b>1 Safty warnings</b> .....	1
<b>2 Product Overview</b> .....	2
2.1 Functions .....	2
2.2 Product Specifications.....	2
2.3 Parts List .....	3
<b>3 Packing List</b> .....	5
<b>4 Product Operation</b> .....	6
4.1 Power Connection .....	6
4.2 Start Up Procedure .....	7
4.3 Proper Shut Down and Care .....	8
4.4 Remote Control.....	9
4.5 Water Joint .....	10
<b>5 Maintenance</b> .....	11
5.1 Impeller .....	11
5.2 Sponge Wheel .....	12
5.3 Water Renting Board .....	16
5.4 Filter Bag .....	16
<b>6 Troubleshooting and waring lights</b> .....	17
<b>7 Safty Checklist</b> .....	19

# 1 Safety Warnings

Please read this manual carefully before using the iCleaner-200.



Before performing maintenance or service on the iCleaner-200 please ensure the power is disconnected to avoid personal injury or property loss.



The iCleaner-200 is designed for use in swimming pools only. Any other use is prohibited and will void manufacturers' warranty.



Do not swim in the pool whilst the iCleaner-200 is in use in order to avoid personal injury.



Do not allow the Power Box to come in contact with water, and it is recommended to be placed in a shady, dry and ventilated area.



When in use, the Power Supply and Caddy Cart must remain 3 meters away from the edge of the pool.



Do not use the iCleaner-200 if there is a chance of thunder storm to avoid personal injury.



Users are only permitted to perform maintenance described in this manual. Any tampering with the Motor Box or Power Supply will void the warranty.



Ensure the iCleaner-200 is fully submerged before turning the power box on.



If the iCleaner-200 is not going to be used for a long time, make sure to disconnect the power, keep it clean and put it in a safe, dry and well-ventilated area.



If the iCleaner-200 stops working, please refer to section 6 "Troubleshooting". If you cannot find the root cause, please contact your local distributor.



The optimum working temperature for the iCleaner-200 is between 10°C and 32°C, avoid direct sunlight when not in use.



The iCleaner-200 is suitable for the swimming pools no deeper than 3 meters.



Lift the iCleaner-200 out of the water using the robot handles, do not lift the iCleaner using the floating cable. Lifting via the cable voids warranty.

## 2 Product Overview

### 2.1 Functions

- ◇ Automatic cleaning: the default mode is automatic, however, this can be overridden using the Remote Control. When the Remote Control is not being used, the iCleaner-200 will return to automatic mode.
- ◇ Overall cleaning: the iCleaner-200 not only cleans the floor of your pool, it also cleans the wall, at the same time, the iCleaner-200 will filter water, and the dirt will be collected into Filter Bag.
- ◇ Timing cleaning: you can select one of three cleaning time with Remote Control (0.5h, 1h or 2 h). The iCleaner-200 will shut down automatically when the selected cycle time is over. The power box must be turned of manually.
- ◇ Manual cleaning: the Remote Control can be used to clean specific areas immediately.
- ◇ Self protection (out of water): Impeller decelerates to a stop in twenty five seconds if the iCleaner-200 senses it is no longer in water, to prevent personal injury and to protect the water pump.
- ◇ Stop protection: the iCleaner-200 will stop if foreign matter retards the Impeller.

### 2.2 Product Parameters

Model	iCleaner-200
Input Voltage	100-240VAC, 50-60Hz
Rated Power	200W
Cycle Time	0.5Hr/1Hr/2Hrs
Floating Cable Standard Length	15m
Filter Bag	Standard : 70um
Water Pump Capacity	20m <sup>3</sup> /h
Moving speed	15m/min
Grade of Waterproof	Host: IP68
Optimum Storage Temperature	0~40°C
Optimum Working Temperature	10~32°C
Dimension ( L*W*H )	452.5*487.8*292mm
Packing Measurement(L*W*H)	574*574*413mm
Gross Weight	20.6kg

## 2.3 Parts List

### Main Body Parts

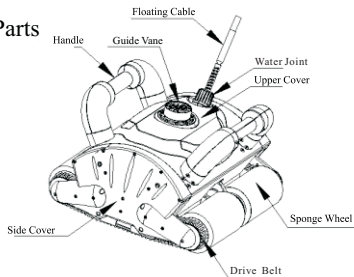

(Pic.2.3.1)

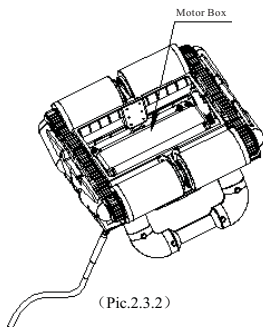
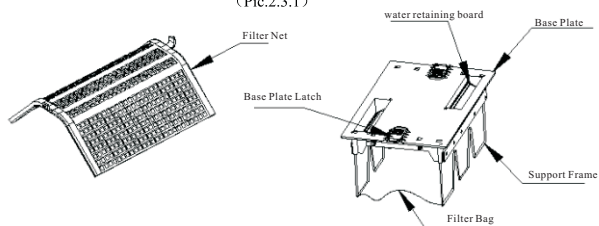

(Pic.2.3.2)

## ※ Power Box Parts

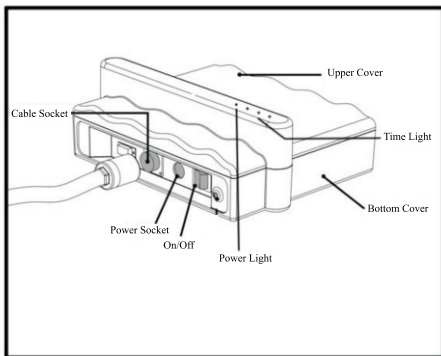

(Pic.2.3.3)

### 3 Packing List

Serial Number	Part Name	Quantity	Remarks
1	Unit Body	1	Host
2	Power Box	1	
3	Remote Control	1	
4	Battery	1	
5	Guide Vane	1	
6	User Manual	1	
7	Warranty Card	1	
8	Certificate of Quality	1	
9	Floating Cable	1	
10	Impeller	1	Spare Parts
11	Filter Bag	1	

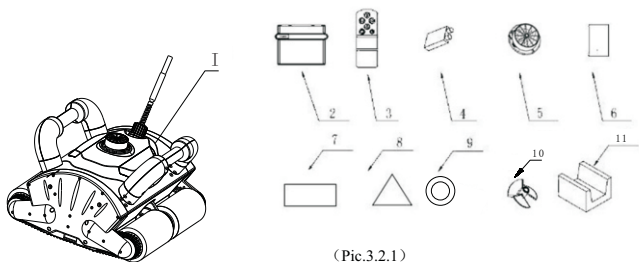

(Pic.3.2.1)

## 4 Product Operation

### 4.1 Power Connection

※ Please connect the Floating Cable to the Cable Socket of Power Box (see Pic. 4.1.1), then connect the Power Box to an outside AC power of 100v/240v 50/60Hz (see Pic.4.1.2). For the complete connection guide please refer Pic.4.1.3

Notices: Do not allow the Power Box to come in contact with water.

Please ensure the Power Box is Kept in a shady, dry & ventilated area.(Refer Page 1.Safety Warning)

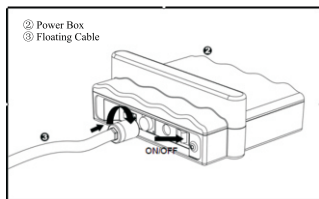

(Pic.4.1.1)

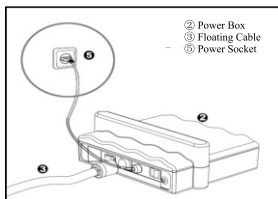

(Pic.4.1.2)

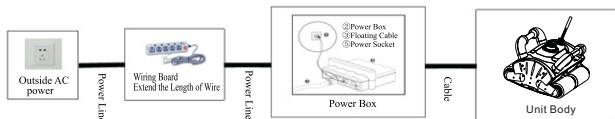

(Pic.4.1.3)



## 4.2 Start Up Procedure

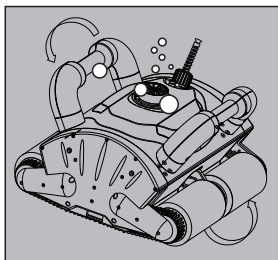

(Pic.4.2.1)

- (1) When placing the iCleaner-200 in the pool: you must wobble the iCleaner-200 according to Pic.4.2.1 to make sure the air inside is released when you put the iCleaner-200 in the water, So it will automatically sink to the bottom of pool.

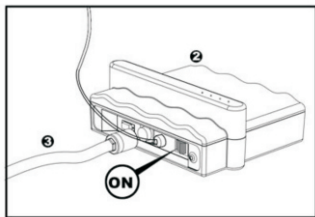

(Pic.4.2.2)

- (2) Start: Press the “ON” button, LED “POWER” indicator. And “0.5H” cycle time LED will illuminate (see pic.4.2.2). You may select 0.5Hr, 1Hr or 2Hrs cleaning time using the “⏸” button on the Remote Control and relative LED indicators will illuminate on the Power Box when selected.

### 4.3 Proper Shut Down and Care

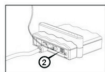

- ② Power Button of Power Box
- ④ Floating Cable
- ③ Handle

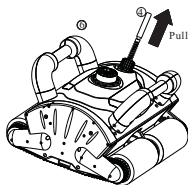

(Pic.4.3.1)

(1) To Shut Down The iCleaner-200: Turn the power switch on the power Box to the off position, once the iCleaner-200 finishes working, pull the Floating Cable slowly until the Handle emerges from the water (Pic.4.3.1), and then pull the iCleaner-200 out of the pool by its Handle.

(2) Clean iCleaner-200: Invert the iCleaner-200 gently onto the floor, unlock the Latch on the Base Plate (Pic.4.3.2) and remove the Filter Bag from Base Plate, clean the Filter Bag (Pic.4.3.3), once clean place the Filter Bag on its frame, reassemble the Base Plate and put it back into the iCleaner-200 once the Filter Bag is dry.

(Note: When re-fitting the Filter Bag to the Base Plate, please ensure the long sides of the Filter Bag are smooth to ensure an easy fit into the base of the iCleaner-200.)

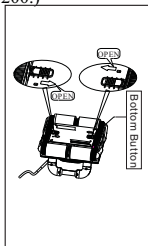

(Pic.4.3.2)

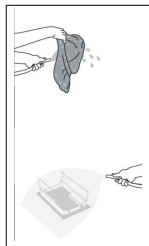
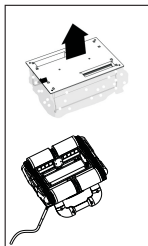

(Pic.4.3.3)

(3) iCleaner-200 Storage: When the iCleaner-200 is dry, disconnect the floating cable reel it in hand-over-hand and place on the iCleaner-200, then store the iCleaner-200 in a dry, well-ventilated area. If you have the Caddy, please put the iCleaner-200 & Floating Cable on to the Caddy Cart, details please refer Pic.4.3.4

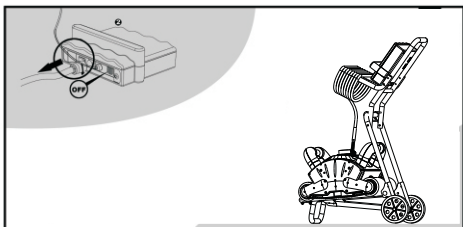

(Pic.4.3.4)

## 4.4 Remote Control

The Remote Control (Pic.4.4.1) includes:

On/Off Power Button

LED Light Indicator

Direction Button

Timer Button

Floor Only Cleaning

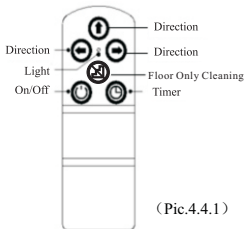

(Pic.4.4.1)

### **On/Off Power Button:**

Turn on or Turn off iCleaner-200

### **Direction Button:**

Control iCleaner-200's movement Backward (⬆️), Left Rotation (⬅️) and Right Rotation (➡️)

### **Timer Button (⌚) :**

Select the timing mode from 0.5hour, 1 hour and 2hours

### **Floor Only Cleaning (🏠) :**

To clean the "Floor Only" press (🏠). To return to floor and wall cleaning, turn the iCleaner-200 off, then on using the remote control (⏻) .

## 4.5 Water Joint

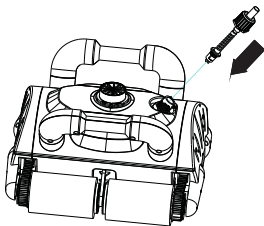

Step 1  
※ Insert water joint into Icleaner-200. (Pic.4.5.1)

(Pic.4.5.1)

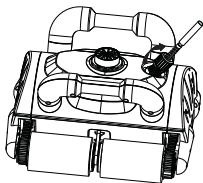

Step 2  
※ Screw down the Lock Nut clockwise. (Pic.4.5.2)

(Pic.4.5.2)

## 5 Maintenance

### 5.1 Impeller

※ Change the Impeller if the old one gets worn or damage

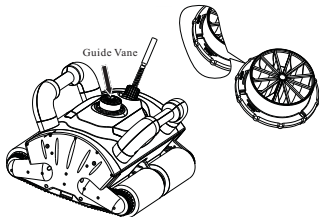

(Pic.5.1.1)

Step 1:

※ Rotate Guide Vane clockwise to remove from the iCleaner-200.(Pic.5.1.1)

Step 2

※ Use a Phillips head screw driver to remove the bolt in the Impeller according the diagram.(Pic.5.1.2)

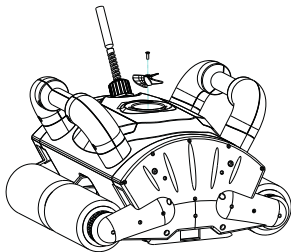

(Pic.5.1.2)

Step 3

※ Replace the new Impeller and assemble Impeller and Guide Vane

## 5.2 Sponge Wheel

Replace the Sponge Wheels if they are badly worn or broken

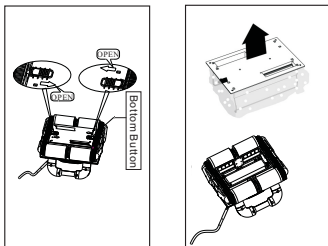

(Pic.5.2.1)

### Step 1

※ Invert the iCleaner-200 on the floor, remove the Base Plate.(Push latch to unlock the Base Plate).(Pic.5.2.1)

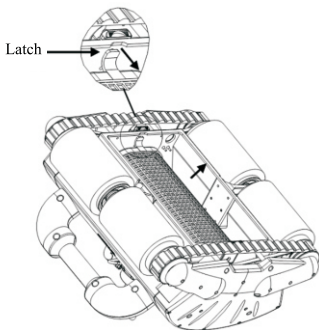

(Pic.5.2.2)

### Step 2

※ Remove the Filter Net from the iCleaner-200 while pressing the Latch according to the diagram.(Pic.5.2.2)

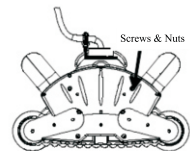

### Step 3

※ Using a Phillips head screwdriver and 7mm ring spanner to undo the six bolts and nuts on the Side Cover, to remove the Side Cover .

( Pic.5.2.3)

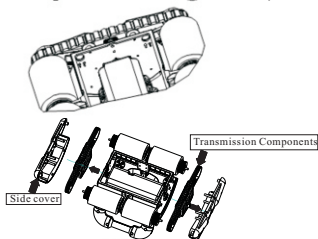

( Pic.5.2.3)

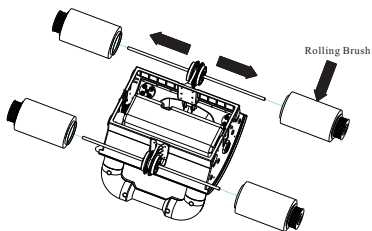

### Step 4

※ Remove the Rolling Brush. (Pic.5.2.4)

( Pic.5.2.4)

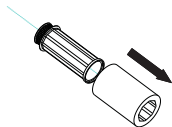

(Pic.5.2.5)

**Step 5**

※ Slide the old sponge wheels off, and replace with new sponge wheels(Pic.5.2.5)

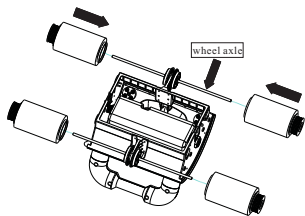

(Pic.5.2.6)

**Step 6**

※ Assemble the Rolling Brush to the axle (Pic.5.2.6) .



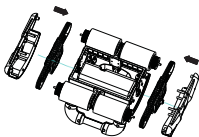

(Pic.5.2.7)

**Step 7**

※ Reassemble the Transmission components and Side Covers to the body of the unit.(Pic.5.2.7)

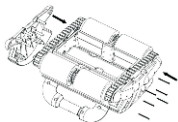

(Pic.5.2.8)

**Step 8**

※ Fasten the transmission components and side covers to the body of the unit using the nuts and bolts.(Pic.5.2.8)

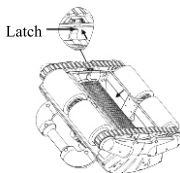

(Pic.5.2.9)

**Step 9**

※Put the Filter Net into the iCleaner-200, press down on the filter net until the Latch locks into the bracket.the filter until the Latch locks into the bracket (Pic.5.2.9)

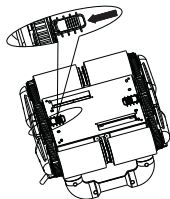

(Pic.5.2.10)

**Step 10**

※ Place the base Plate into iCleaner-200, pressing down until the latches lock into place. (Pic.5.2.10)

※ Replacing the Sponge Wheels is now completed

## 5.3 Water Retaining Board

### Replace the Water Retaining Board if they are broken(Pic 5.3.1)

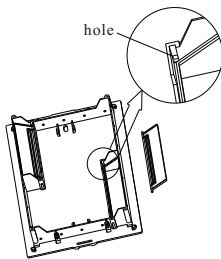

Pic.5.3.1 Replace the water retaining board

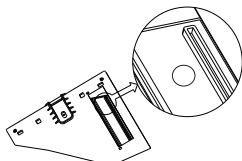

Pic.5.3.2

#### Step 1

※ Remove the base plate from the iCleaner and remove the filter bag, then open the water retaining board to the vertical position and carefully slide the water retaining board to one end, remove the water retaining board carefully.

#### Step 2

※ Insert one end of the water retaining board into the locating holes on the base plate, then insert the other end of the water retaining board into the base plate, and make sure the water retaining board does not have a bend in it(if it does, gently push the hinged edge,until it clicks into position).

Note: The water retaining board is fitted correctly, please refer to pic.5.3.2

## 5.4 Filter Bag

When the Filter Bag is dirty as shown in pic. 5.4.1 or if the Filter Bag has been damaged, please refer to chapter 4.3.2 to replace Filter Bag.

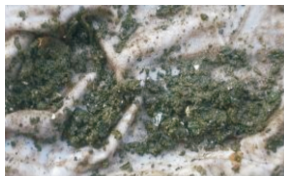

Pic.5.4.1 Filter Bag is full

## 6 Troubleshooting and Warning Lights

Commonfault	Reason	Solution	Remarks
iCleaner-200 doesn't work	The socket is not plugged in	Plug in the power lead	Please turn off the power before you perform any maintenance on the iCleaner-200
	Connection is wrong	Check the connection	
Weak pumping	Impeller is jammed or dirty	clean the Impeller	
	Impeller is damage	Replace the Impeller	
	Filter Bag is full	clean the Filter Bag	
iCleaner-200 is turning to one side when it moves	Drive Belt is loosen or broken at one side	replace the drive Belt	
	The Filter Bag is full	Clean Filter Bag	
iCleaner-200 will not climbs wall	Filter Bag is full	clean the Filter Bag	
	Drive Belt is loosen or broken	replace the Drive Belt	
	Sponge wheel wear	Replace the Sponge wheel	
	axis sleeves wear	replace axis sleeves	
iCleaner-200 will not sink to the bottom of the pool	The sponge wheel don't soak enough	you must hold cleaner in water and make sure sponge wheel soak enough, normal time is about 5 -15 minutes	
	It has air inside the machine	Wobble iCleaner-200 and make sure air released	
Dirt is coming through the guide vane.	Belt of Filter Bag is loosen or broken. Dirt is too fine for the filter bag	Replace broken filter bag	

Note: The Power Box MUST BE DISCONNECTED from the power supply prior to conducting any maintenance on the iCleaner-200. Contact your local distributor, or place of purchase for problems not covered in Trouble Shooting Guide.

<b>Indicator light</b>	<b>Failure</b>	<b>Solution</b>
Green light flashing	The iCleaner has stopped due to lack of water	Return the robot to deeper water and restart
Yellow light flashing	The Motor Pump inside the robot has over heated	Contact the supplier for support
Blue light flashing	The robot is upside down	Turn the iCleaner over, and restart using the remote control or power switch
Blue and green lights flashing	The walking (drive wheel) motors are over loaded	1. Check the walking motors, Drive tracks and tacking belts for debris or damage. 2. Clear debris or replace parts parts and restart the iCleaner.
Blue 、 green and yellow lights flashing	The water pump is over loaded	1. Turn the robot off, check the impeller for debris, or damage. 2. Clear or replace impeller, then restart the iCleaner.

## 7 Safty Checklist

- ◇ Please shut down the iCleaner-200 according to chapter 4.3 when you have finished cleaning the pool.
- ◇ Please inspect and clean the impeller & Guide Vane according to chapter 5.1, after use.
- ◇ If you are not going to use the iCleaner-200 for an extended period of time, make sure iCleaner-200 & Power Box is turned off, and store it in a dry, shady & well ventilated area, with a temperature range between 0-40°C.
- ◇ If you want to reuse iCleaner-200 after it has been stored for an extended period of time, please check the iCleaner-200 for visual damage (cracks & rust) prior to use. Once you are sure iCleaner-200 is free from damage, test run it, and if it performs as expected, then allow it to run automatically.
- ◇ If the iCleaner-200 requires repair, please contact your local distributor, or contact [service@ichroboter.com](mailto:service@ichroboter.com).



## **Hangzhou Gaoyue Technology Co., Ltd**

Add: 2/F Building #6, Haihong Science Park Phase II, Jinger Road, Qixianqiao Village, Liangzhu Street, Yuhang District, Hangzhou 311113, China

Tel: +86-571-88759508

Fax: +86-571-88759501

E-mail: [sale@ichroboter.com](mailto:sale@ichroboter.com)

[www.ichroboter.com](http://www.ichroboter.com)

















